

DLFEHB

Owner's Manual

Ductless Split Unit System

Heat Pump Sizes 09, 12, 18, 24, 30, 36 - Cooling Only Sizes 09, 12, 18, 24

TABLE OF CONTENTS

PAGE

A NOTE ABOUT SAFETY2

GENERAL2

PART NAMES AND DISPLAY3

WIRELESS REMOTE CONTROL.....4

REMOTE CONTROL6

OPERATING TEMPERATURE.....8

FEATURES9

CLEANING, MAINTENANCE AND TROUBLESHOOTING11

NOTE TO EQUIPMENT OWNER:

Please read this Owner's Information Manual carefully before installing and using this appliance and keep this manual for future reference.

For your convenience, please record the model and serial numbers of your new equipment in the spaces provided. This information, along with the installation data and dealer contact information, will be helpful should your system require maintenance or service.

UNIT INFORMATION

Model # _____

Serial # _____

INSTALLATION INFORMATION

Date Installed _____

DEALERSHIP CONTACT INFORMATION

Company Name: _____

Address: _____

Phone Number: _____

Technician Name: _____

A NOTE ABOUT SAFETY

Any time you see this symbol  in manuals, instructions and on the unit, be aware of the potential for personal injury. **There are 3 levels of precaution:**

1. **DANGER** identifies the most serious hazards which will result in severe personal injury or death.
2. **WARNING** signifies hazards that could result in personal injury or death.
3. **CAUTION** is used to identify unsafe practices which could result in minor personal injury or product and property damage.

NOTE is used to highlight suggestions which will result in enhanced installation, reliability, or operation.

WARNING

PERSONAL INJURY, DEATH AND / OR PROPERTY DAMAGE HAZARD

Failure to follow this warning could result in personal injury, death or property damage.

Improper installation, adjustment, alteration, service, maintenance, or use can cause explosion, fire, electrical shock, or other conditions which may cause personal injury or property damage. Consult a qualified installer, service agency, or your distributor or branch for information or assistance. The qualified installer or service agency must use factory-authorized kits or accessories when modifying this product.

Read and follow all instructions and warnings, including labels shipped with or attached to unit before operating your new air conditioner.

GENERAL

The high wall fan coil unit provides quiet, maximum comfort. In addition to cooling and/or heating, the high wall fan coil unit matched with an outdoor condensing unit filters and dehumidifies the air in the room to provide maximum comfort.

IMPORTANT: The high wall fan coil unit should be installed by authorized personnel only; using approved tubing and accessories. If technical assistance, service or repair is needed, contact the installer. The high wall fan coil unit can be set up and operated from the remote control (provided). If the remote is misplaced, the system can be operated from the "Auto" setting on the unit.

Operating Modes

The high wall fan coil unit has five operating modes:

- **FAN Only**
- **AUTO**
- **HEATING (heat pumps only)**
- **COOLING**
- **DEHUMIDIFICATION**

FAN Only

In the **FAN Only** mode, the system filters and circulates the room air without changing room air temperature.

AUTO

In the **AUTO** mode, the system automatically cools or heats the room according to the user-selected set point.

NOTE: AUTO mode is recommended for use on single zone applications ONLY. Using AUTO CHANGEOVER on multi-zone applications could set an indoor unit to STANDBY mode, indicated with two dashes (--) on the display, which will turn off the indoor unit until all the indoor units are in the same mode (COOLING or HEATING). HEATING is the system's priority mode. Simultaneous HEATING and COOLING is not allowed.

HEATING (Heat Pump models only)

In the **HEATING** mode, the system heats and filters the room air.

COOLING

In the **COOLING** mode, the system cools, dries and filters the room air.

DEHUMIDIFICATION (DRY)

In the **DEHUMIDIFICATION** mode, the system dries, filters and slightly cools the room air temperature. This mode prioritizes air dehumidification but it does not take the place of a dehumidifier.

Wireless Remote Control

The remote control transmits commands to set up and operate the system. The control has a window display panel that displays the current system status. The control can be secured to a surface when used with the mounting bracket provided.

Wired Remote Control (Optional)

Refer to the Wired Controller manual.

24V Interface (Optional)

Allows the control of the Ductless System with a third party thermostat.

Smartphone Control (Optional)

Capability to be controlled by a smartphone adding the Wi-Fi® Interface Kit **KSAIF0301AAA (sold separately)**.

PART NAMES AND DISPLAY

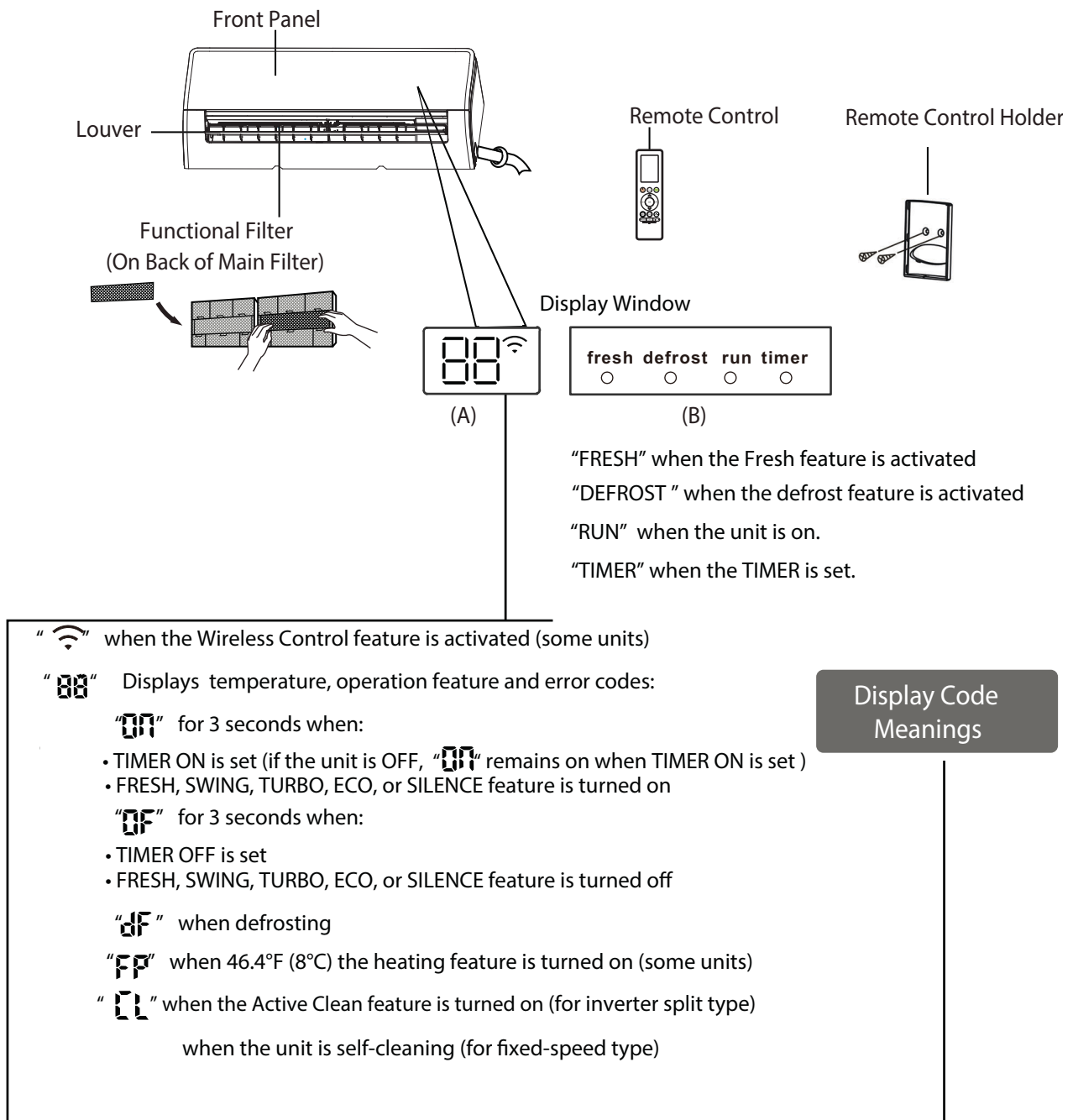

Fig. 1 — Unit Specifications and Features

WIRELESS REMOTE CONTROL

Before using your new air conditioner, familiarize yourself with the wireless remote control.

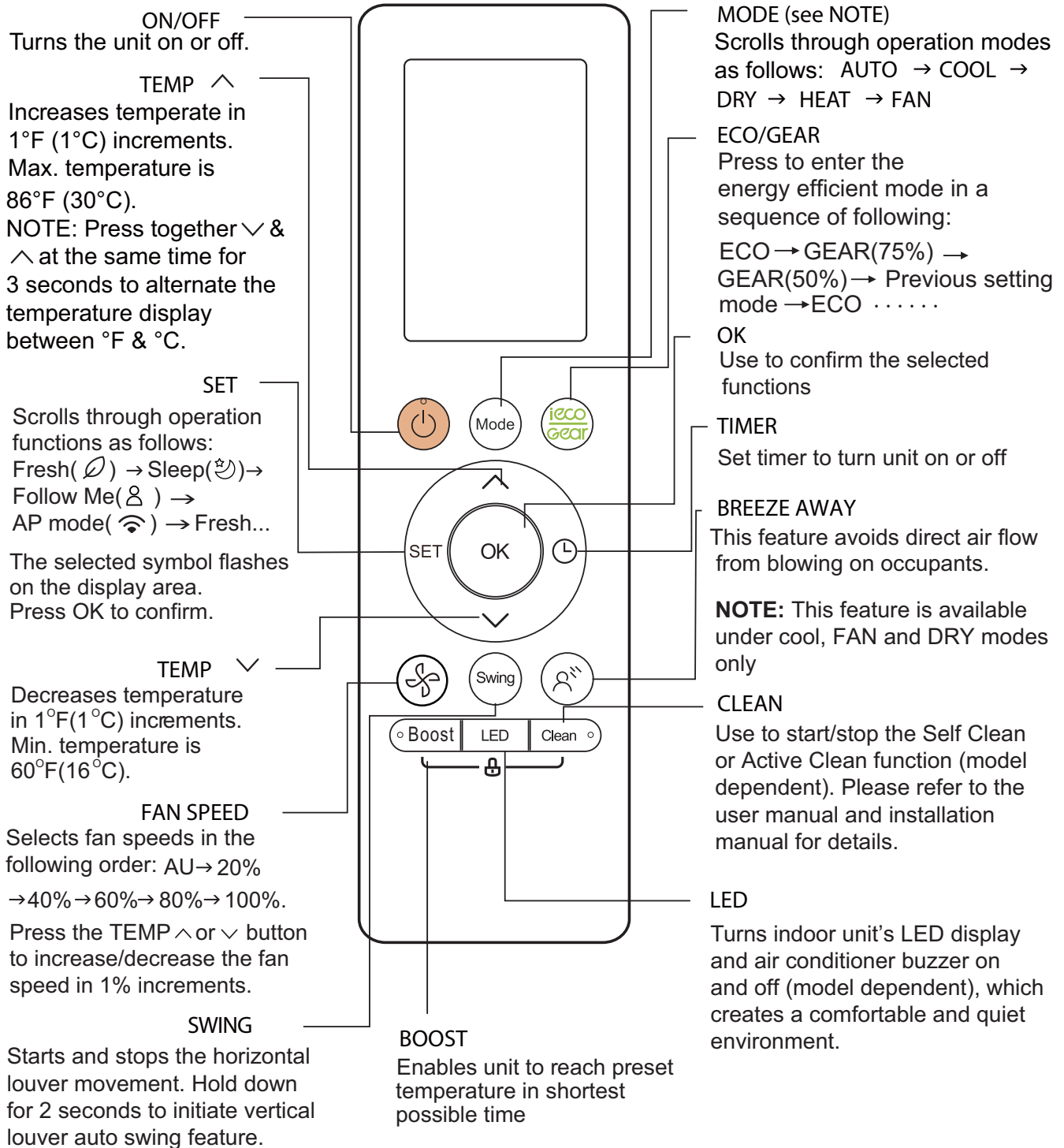

Fig. 2 — Remote Control Functions

NOTE: For Cooling only models, AUTO mode and HEAT mode are not available.

WIRELESS REMOTE CONTROL LCD SCREEN INDICATORS

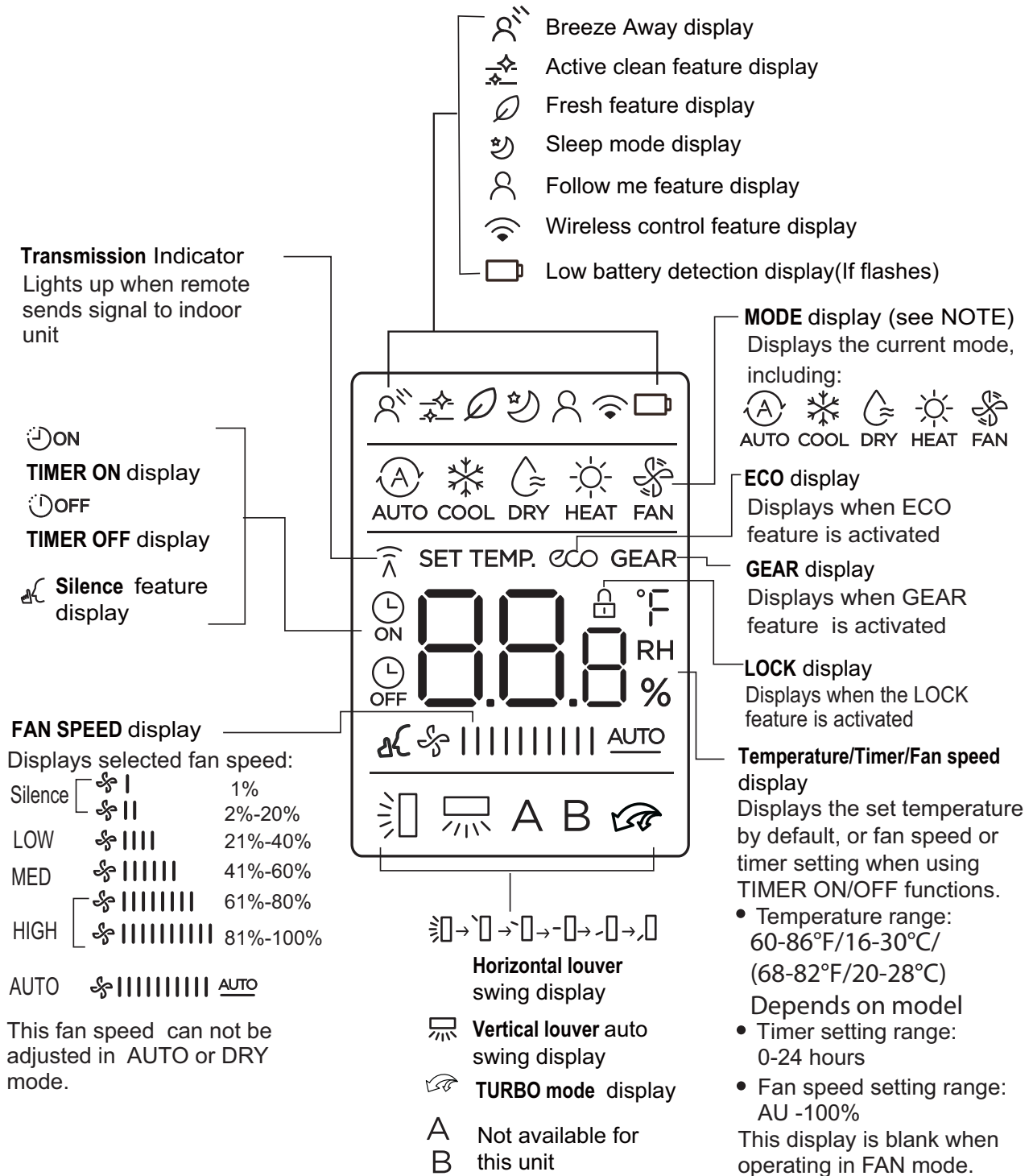

Fig. 3 — Wireless Remote Controller Indicators

NOTE: For COOLING only models, AUTO mode and HEAT mode are not available.

REMOTE CONTROL



CAUTION

EQUIPMENT DAMAGE HAZARD

Failure to follow this caution may result in equipment damage. Handle the control with care and avoid getting the control wet.

IMPORTANT: The remote control can operate the unit from a distance of up to 26 ft. (8 m) as long as there are no obstructions. When the timer function is used, the remote control should be kept in the vicinity of the fan coil (within 26 ft. / 8 m).

The remote control can perform the following basic functions:

- Turn the system ON and OFF
- Select the operating mode
- Adjust room air temperature set point and fan speed
- Adjust right-left airflow direction

Refer to the “WIRELESS REMOTE CONTROL” on page 4 for a detailed description of all the capabilities of the remote control.

Battery Installation

Two AAA 1.5v alkaline batteries (included) are required for remote control operation.

To install or replace batteries:

1. Slide the back cover off the control to open the battery compartment.
2. Insert the batteries. Follow the polarity markings inside the battery compartment.
3. Replace the battery compartment cover.

NOTES:

1. When replacing batteries, do not use old batteries or a different type battery. This may cause the remote control to malfunction.
2. If the remote is not going to be used for several weeks, remove the batteries. Otherwise, battery leakage may damage the remote control.
3. The average battery life under normal use is about 6 months.
4. Replace the batteries when there is no audible beep from the indoor unit or if the Transmission Indicator fails to light.

NOTE: When batteries are removed, the remote control erases all presets (e.g., Follow Me). The presets must be restored after the insertion of new batteries.

BASIC REMOTE CONTROL OPERATION

Before operation, ensure the unit is plugged in and power is available.

COOL Mode

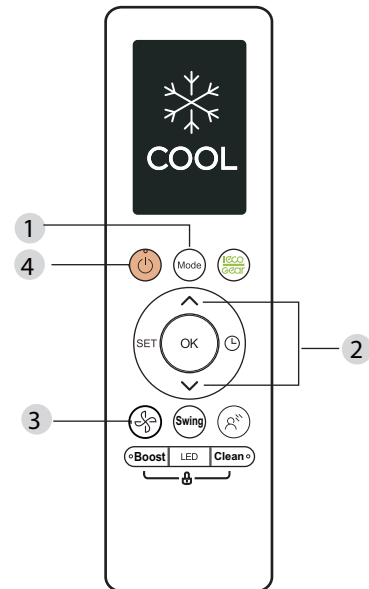
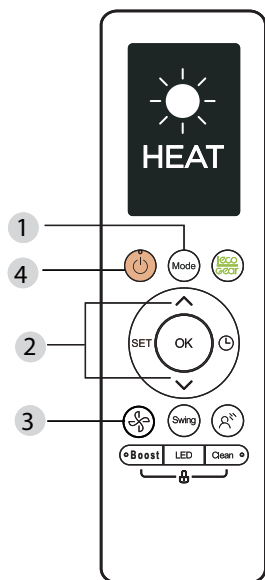

Fig. 4 — COOL Mode

1. Press **MODE** to select the **COOL** mode.
2. Set your desired temperature using **TEMP ^** or **TEMP v**.
3. Press **FAN** to select the fan speed in a range of AU*100%.
4. Press **ON/OFF** to start the unit.

Setting Temperature

The operating temperature range for units is 60-86°F (16-30°C)/(68-82 °F (20-28°C) (depends on model). You can increase or decrease the set temperature in 1°F(0.5°C) increments.

HEAT Mode (Not available for Cooling Only models)**Fig. 5 — HEAT Mode**

1. Press **MODE** to select the **HEAT** mode.
2. Set your desired temperature using **TEMP ^** or **TEMP v**.
3. Press **FAN** to select the fan speed in the range of AU-100%.

NOTE: As the outdoor temperature drops, the performance of your unit's **HEAT** function may be affected. In such instances, we recommend using this air conditioner in conjunction with other heating appliances.

AUTO Mode (Not available for Cooling Only models)

In **AUTO** mode, the unit automatically selects the **COOL**, **FAN**, or **HEAT** operation based on the set temperature.

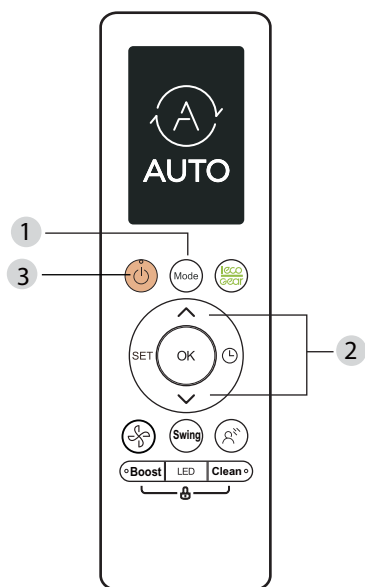
**Fig. 6 — AUTO Mode**

1. Press **MODE** to select **AUTO**.
2. Set your desired temperature using **TEMP ^** or **TEMP v**.
3. Press **ON/OFF** to start the unit.

NOTE: **FAN** Speed can not be set in the **AUTO** mode.

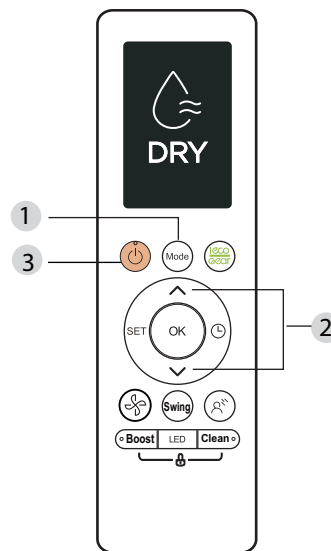
DRY Mode**Fig. 7 — DRY Mode**

1. Press **MODE** to select the **DRY** mode.
2. Set your desired temperature using **TEMP ^** or **TEMP v**.
3. Press **ON/OFF** to start the unit.

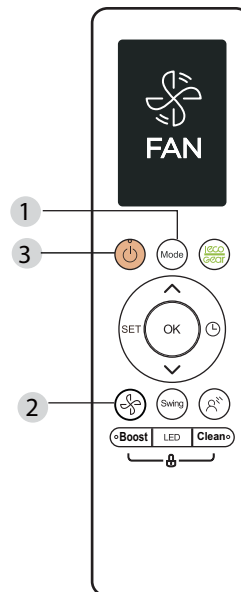
FAN Mode**Fig. 8 — FAN Mode**

1. Press **MODE** to select the **FAN** mode.
2. Press **FAN** to select the fan speed in the range of AU-100%.
3. Press **ON/OFF** to start the unit.

Remote Control Operation - Quick Start

NOTE: When transmitting a command from the remote control to the unit, be sure to point the control toward the right side of the unit. The unit confirms receipt of a command by sounding an audible beep.

1. Turn the unit on by pushing **ON/OFF**.

NOTE: If there is a preference for °C rather than °F (default), press and hold the + and - temperature set point buttons together for approximately 3 seconds.

2. Select the desired mode by pushing **MODE**.

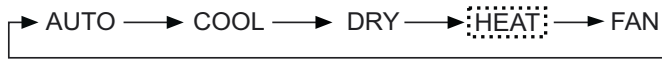

Fig. 9 —Modes

3. Select the temperature set point by pointing the control toward the unit and pressing the increase/decrease temperature set point buttons until the desired temperature appears on screen.
4. Press **FAN** to select the desired fan speed.

NOTE: If the unit is operating in DRY or AUTO mode, the fan speed will be automatically set and cannot be adjusted.

Set the airflow direction. When the unit is turned on, the **Up-Down** airflow louvers default to the cooling or heating position. The user can adjust the horizontal **Up-Down** airflow louver position by pushing **DIRECT** or have continuous louver movement by pressing **SWING**.

OPERATING TEMPERATURE

When your air conditioner is used outside of the following temperature ranges, certain safety protection features may activate and cause the unit to disable.

Table 1 — Inverter Split Type

	COOL MODE	HEAT MODE	DRY MODE
Room Temperature	62°F - 90°F (17°C - 32°C)	32°F - 86°F (0°C - 30°C)	50°F - 90°F (10°C - 32°C)
Outdoor Temperature	32°F - 122°F (0°C - 50°C)	5°F - 75°F (-15°C - 24°C)	32°F - 122°F (0°C - 50°C)
	5°F - 122°F (-15°C - 50°C) For models with low temp. cooling systems.)		
	32°F - 126°F (0°C - 52°C) (For special tropical models)		32°F - 126°F (0°C - 52°C) (For special tropical models)

NOTE: FOR OUTDOOR UNITS WITH BASEPAN HEATER OR CRANKCASE HEATER.

When the outside temperature is below 32°F (0°C), we strongly recommend maintaining power on the unit to ensure smooth ongoing performance.

To optimize unit performance, perform the following:

- Keep doors and windows closed
- Limit energy usage by using **TIMER ON** and **TIMER OFF** functions.
- Do not block air inlets or outlets.
- Regularly inspect and clean air filters.

FEATURES

The unit provides the following features for added comfort and safety.

Auto-Restart (some units)

If the unit loses power, it automatically restarts with the prior settings once power has been restored.

Anti-mildew (some units)

When turning off the unit from **COOL**, **AUTO (COOL)**, or **DRY** modes, the air conditioner continues to operate at very low power to dry up any condensed water and prevent mildew growth.

Wireless Control (some units)

Wireless control allows users to control the air conditioner using a mobile phone and a wireless connection. For the USB device access, replacement, maintenance operations must be carried out by professional staff.

Louver Angle Memory (some units)

When turning on the unit, the louver automatically resumes its former angle.

Active Clean (some units)

The **Active Clean Technology** washes away dust, mold, and grease that may cause odors when it adheres to the heat exchanger by automatically freezing and then rapidly thawing the frost. The operation produces more condensed water to improve the cleaning effect.

After cleaning, the blower wheel keeps operating with hot air to blow-dry the evaporator, thus preventing the growth of mold and keeping the inside clean. When this function is turned on, the indoor unit window displays **CL**. After 20 to 45 minutes, the unit turns off automatically and cancels the function.

Breeze Away (some units)

This feature avoids direct air flow from blowing on inhabitants.

Refrigerant Leak Detection (some units)

The indoor unit automatically displays **EL0C** when it detects refrigerant leakage.

Sleep Operation

The **SLEEP** function is used to decrease energy use while inhabitants sleep and do not require the same temperature settings to maintain comfort. This function can only be activated via the remote control.

NOTE: The SLEEP function is not available in the FAN or DRY mode.

Press **SLEEP** when you are ready to sleep. When in the **COOL** mode, the unit increases the temperature by 2°F (1°C) after 1 hour, then increases an additional 2°F (1°C) after another hour. When in the **HEAT** mode, the unit decreases the temperature by 2°F (1°C) after 1 hour, and decreases an additional 2°F (1°C) after another hour.

The **SLEEP** feature stops after 8 hours and the system keeps running under the final setting.

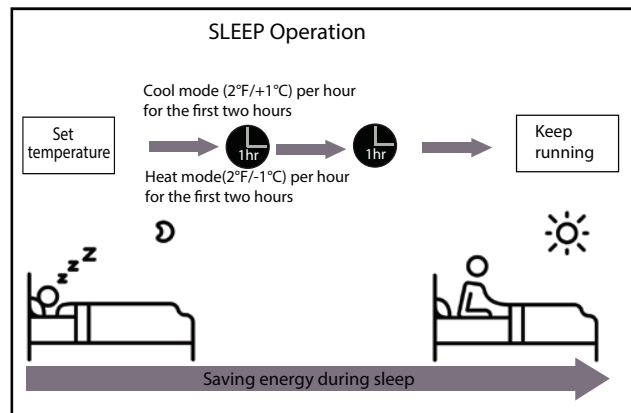

Fig. 10 — SLEEP Operation

Resetting the Remote Control

If the batteries in the remote control are removed, the current settings cancel and the control returns to the initial settings and enters the **STANDBY mode**. Push **ON/OFF** to activate.

NOTE: For multi-zone air conditioners, the following functions are not available: ACTIVE CLEAN, SILENCE, BREEZE AWAY, REFRIGERANT LEAKAGE DETECTION and ECO.

Setting Vertical Angle of Air Flow

While the unit is on, press **SWING** on the remote control to initiate the horizontal louver **AUTO SWING** feature.

NOTE: When using the COOL or DRY mode, do not set the louver at too high of an angle for long periods of time. Doing so may cause water to condense on the louver blade, which may drop on floors or furnishings.

NOTE: When using the COOL or HEAT mode, setting the louver at too high of an angle can reduce the performance of the unit due to restricted air flow.

Setting Horizontal Angle of Air Flow

The horizontal angle of the airflow must be set manually. Grip the deflector rod (see Fig. 12) and manually adjust it to your preferred direction. For some units, the horizontal angle of the airflow can be set by remote control. Refer to the Remote Control Manual.

Manual Operation (Without Remote Control)



CAUTION

The **MANUAL** button is intended for testing purposes and emergency operation **only**. **Do not** use this function unless the remote control is lost and it is absolutely necessary. To restore regular operation, use the remote control to activate the unit. Unit must be turned off before initiating the manual operation.

Use the following steps to operate the unit manually:

1. Open the front panel of the indoor unit.
2. Locate the **MANUAL CONTROL** button on the right-hand side of the unit.
3. Press **MANUAL CONTROL** one time to activate the **FORCED AUTO** mode.
4. Press **MANUAL CONTROL** again to activate the **FORCED COOLING** mode.
5. Press **MANUAL CONTROL** a third time to turn the unit off.
6. Close the front panel.

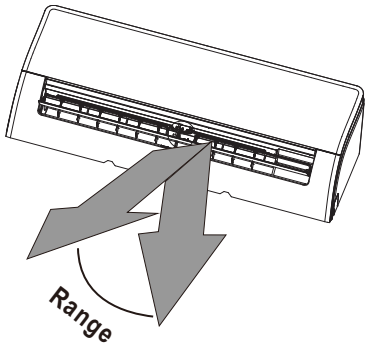

Fig. 11 — Range

NOTE: DO NOT move the louver by hand. Doing so takes the louver out of sync. Should this occur, turn off the unit and unplug it for a few seconds, then restart the unit. Doing so resets the louver.



CAUTION

DO NOT put your fingers in or near the blower and suction unit side of the unit. The high-speed fan inside the unit may cause injury.

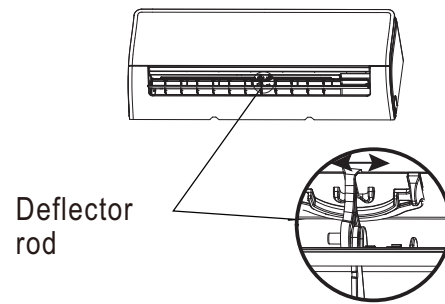

Deflector rod

Fig. 12 — Deflector Rod

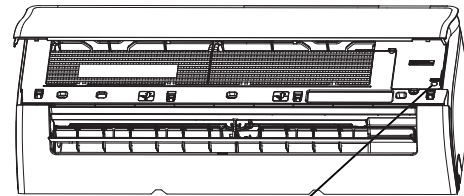

Manual Control Button

Fig. 13 — Manual Control Button

CLEANING, MAINTENANCE AND TROUBLESHOOTING



CAUTION

ELECTRICAL SHOCK HAZARD

Failure to follow this caution may result in personal injury or death. Always turn off power to the system before performing any cleaning or maintenance to the system. Turn off the outdoor disconnect switch located near outdoor unit.

Be sure to disconnect the indoor unit if on a separate switch.



CAUTION

EQUIPMENT DAMAGE/OPERATION HAZARD

Failure to follow this caution may result in equipment damage or improper unit operation.

Operating the system with dirty air filters may damage the indoor unit and could cause reduced cooling performance, intermittent system operation, frost build-up on indoor coil or blown fuses.

Periodic Maintenance

Periodic maintenance is recommended to ensure proper operation of the unit. Recommended maintenance intervals may vary depending on the installation environment, e.g., dusty zones, etc. Refer to Table 2 on page 13.



CAUTION

Only use a soft, dry cloth to wipe the unit clean. If the unit is especially dirty, you can use a cloth soaked in warm water to wipe it clean.

Do not use chemicals or chemically treated cloths to clean the unit.

Do not use benzene, paint thinner, polishing powder or other solvents to clean the unit. They can cause the plastic surface to crack or deform.

Do not use water hotter than 104°F (40°C) to clean the front panel. This can cause the panel to deform or become discolored.

Cleaning the Air Filters

A clogged air conditioner can reduce the cooling efficiency of your unit, and can also be bad for your health. Make sure to clean the filter once every two weeks.

1. Lift the front panel of the indoor unit.
2. First press the tab on the end of filter to loosen the buckle, lift it up, then pull it towards you.
3. Now pull the filter out.
4. If the filter has a small air freshening filter, unclip it from the larger filter. Clean the air freshening filter with a hand-held vacuum.
5. Clean the large air filter with warm, soapy water. Be sure to use a mild detergent.
6. Rinse the filter with fresh water, then shake off any excess water.
7. Dry the filter in a cool, dry place, and keep it out of direct sunlight.
8. Once dry, re-clip the air freshening filter to the larger filter, then slide it back into the indoor unit.
9. Close the front panel of the indoor unit.

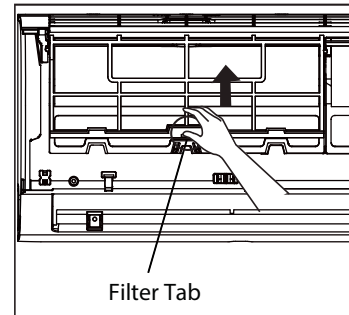

Fig. 14 — Filter Tab

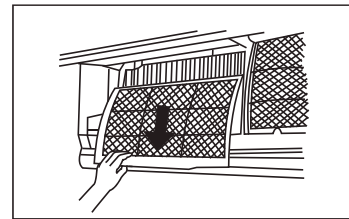
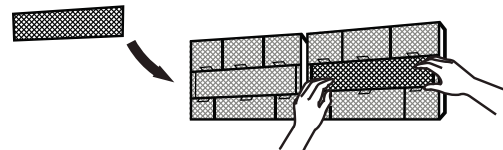

Fig. 15 — Remove the Filter



Remove the air freshening filter from the back of the larger filter (some units)

Fig. 16 — Remove the air freshening filter

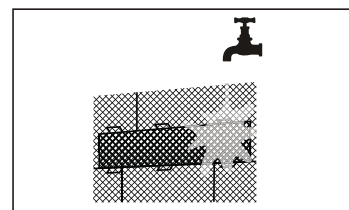

Fig. 17 — Rinse the filter



CAUTION

Do not touch air freshening (Plasma) filter for at least 10 minutes after turning off the unit.



CAUTION

Before changing the filter or cleaning, turn off the unit and disconnect its power supply.

When removing the filter, do not touch the metal parts in the unit. The sharp metal edges can cut you.

Do not use water to clean the inside of the indoor unit. This can destroy insulation and cause electrical shock.

Do not expose filter to direct sunlight when drying. This can shrink the filter.

Air Filter Reminders (Optional)

After 240 hours of use, the display window on the indoor unit will flash "CL" This is a reminder to clean the filter. After 15 seconds, the unit reverts to its previous display. To reset the reminder, press LED on the remote control 4 times, or press the MANUAL CONTROL button 3 times. If the reminder is not reset, the "CL" indicator flashes again once the unit is restarted.

Air Filter Replacement Reminder

After 2,880 hours of use, the display window on the indoor unit will flash "nF". This is a reminder to replace the filter. After 15 seconds, the unit reverts to its previous display. To reset the reminder, press LED on the remote control 4 times, or press the MANUAL CONTROL button 3 times. If the reminder is not reset the reminder, the "nF" indicator flashes again once the unit is restarted.

⚠ CAUTION

Any maintenance and cleaning of the outdoor unit should be performed by an authorized dealer or a licensed service provider.

Any unit repairs should be performed by an authorized dealer or a licensed service provider.

Preparing for Extended Shutdown Period

Clean the filters and reposition them in the unit. Operate the unit in FAN ONLY mode for 12 hours to dry all internal parts. Turn the main power supply off and remove the batteries from the remote control.

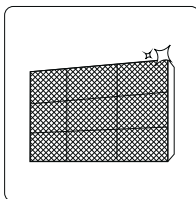

Clean all filters

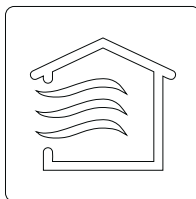

Turn on the FAN function until unit dries out completely

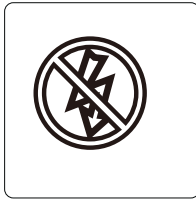

Turn off the unit and disconnect the power

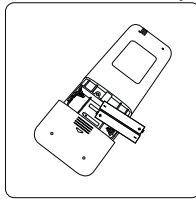

Remove batteries from remote control

Fig. 18 — Extended Shutdown Period Steps

Pre-Season Inspection

After long periods of non-use, or before periods of frequent use, perform the following steps.

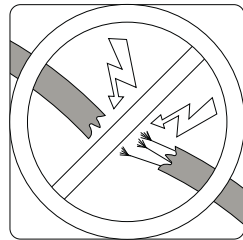

Check for damaged wires

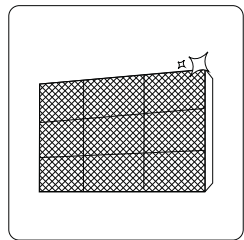

Clean all filters



Check for leaks

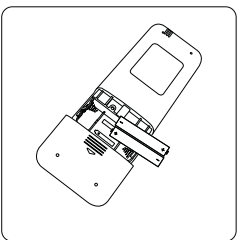

Replace batteries from remote

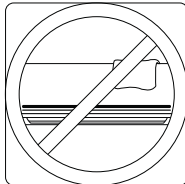

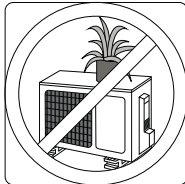

Make sure nothing is blocking all air inlets and outlets

Fig. 19 — Pre-Season Inspection

System Operation Recommendations

The items outlined in the following list help to assure proper system operation:

- Replace both remote control batteries at the same time.
- Point the remote control toward the unit display panel when transmitting a command.
- Keep doors and windows closed while unit is operating.
- Contact an authorized service representative if a problem arises that cannot be easily resolved.
- Do not perform cleaning or maintenance activities while the unit is on.
- Keep the display panel on the unit away from direct sunlight and heat as this may interfere with remote control transmissions.
- Do not block air intakes and outlets on the indoor or outdoor units.

Energy Saving Recommendations

The following recommendations add greater efficiency to the ductless system:

- Select a comfortable thermostat setting and leave it at chosen setting. Avoid continually raising and lowering the setting.
- Keep the filter clean. Frequent cleaning may be necessary depending on indoor air quality.
- Use drapes, curtains or shades to keep direct sunlight from heating the room on very hot days.
- Limit the unit's run time by using the TIMER function.
- Do not obstruct the air intake on the front panel.
- Turn on the air conditioning unit before the indoor air becomes too uncomfortable.

TROUBLESHOOTING (CONT)

Refer to Table 2 before contacting your local dealer.

Table 2 — Periodic Maintenance

INDOOR UNIT	EVERY MONTH	EVERY 6 MONTHS	EVERY YEAR
Clean Air Filter*	•		•
Replace Carbon Filter		•	•
Change Remote Control Batteries (as needed)			
OUTDOOR UNIT	EVERY MONTH	EVERY 6 MONTHS	EVERY YEAR
Clean Outdoor Coil from Outside		•	
Clean Outdoor Coil from Inside†			•
Blow Air Over Electric Parts†			•
Check Electric Connection Tightening†			•
Clean Fan Wheel†			•
Check Fan Tightening†			•
Clean Drain Pans†			•

* Increase frequency in dusty zones.

† Maintenance to be carried out by qualified service personnel. Refer to the Installation Manual

The problems listed in Table 3 are not a malfunction and in most situations will not require repairs.

Table 3 — Common Issues

Issue	Possible Causes
Unit does not turn on when pressing ON/OFF	The unit has a 3-minute protection feature that prevents the unit from overloading. The unit cannot restart within three minutes of being turned off.
The unit changes from COOL/HEAT mode to FAN mode	The unit may change its setting to prevent frost from forming on the unit. Once the temperature increases, the unit will start operating in the previously selected mode. The set temperature has been reached, at which point the unit turns off the compressor. The unit continues to operate once the temperature fluctuates again.
The indoor unit emits white mist	In humid regions, a large temperature difference between the room's air and the conditioned air can cause white mist.
Both the indoor and outdoor units emit white mist	When the unit restarts in HEAT mode after defrosting, white mist may be emitted due to moisture generated from the defrosting process.
The indoor unit makes noises	A rushing air sound may occur when the louver resets its position. A squeaking sound may occur after running the unit in HEAT mode due to expansion and contraction of the unit's plastic parts.
Both the indoor unit and outdoor unit make noises	Low hissing sound during operation: This is normal and is caused by refrigerant gas flowing through both indoor and outdoor units. Low hissing sound when the system starts, has just stopped running, or is defrosting: This noise is normal and is caused by the refrigerant gas stopping or changing direction. Squeaking sound: Normal expansion and contraction of plastic and metal parts caused by temperature changes during operation can cause squeaking noises.
The outdoor unit makes noises	The unit makes different sounds based on its current operating mode.
Dust is emitted from either the indoor or outdoor unit	The unit may accumulate dust during extended periods of non-use, which will be emitted when the unit is turned on. This can be mitigated by covering the unit during long periods of inactivity.
The unit emits a bad odor	The unit may absorb odors from the environment (such as furniture, cooking, cigarettes, etc.) which will be emitted during operations. The unit's filters have become moldy and should be cleaned.
The outdoor unit fan does not operate	During operation, the fan speed is controlled to optimize product operation.
Operation is erratic, unpredictable, or unit is unresponsive	Interference from cell phone towers and remote boosters may cause the unit to malfunction. In this case, try the following: <ul style="list-style-type: none"> • Disconnect the power, then reconnect. • Press ON/OFF on the remote control to restart the operation.

NOTE: If a problem persists, contact a local dealer or your nearest customer service center. Provide them with a detailed description of the unit malfunction as well as your model number.

TROUBLESHOOTING (CONT)

Table 4 — Troubleshooting

PROBLEM	POSSIBLE CAUSE	SOLUTION
Poor Cooling Performance	Temperature setting may be higher than ambient room temperature	Lower the temperature setting
	The heat exchanger on the indoor or outdoor unit is dirty	Clean the affected heat exchanger
	The air filter is dirty	Remove the filter and clean it according to instructions
	The air inlet or outlet of either unit is blocked	Turn the unit off, remove the obstruction and turn it back on
	Doors and windows are open	Ensure all doors and windows are closed while operating the unit
	Excessive heat is generated by sunlight	Close windows and curtains during periods of high heat or direct sunlight
	Too many heat sources in the room (people, computers, electronics, etc.)	Reduce amount of heat sources
	Low refrigerant due to leak or long-term use	Check for leaks, re-seal if necessary and top off refrigerant
	SILENCE function is activated (optional function)	SILENCE function can lower product performance by reducing operating frequency. Turn off the SILENCE function.
The unit is not working	Power failure	Wait for the power to be restored
	The power is turned off	Turn on the power
	The fuse is burned out	Replace the fuse
	Remote control batteries are dead	Replace batteries
	The Unit's 3-minute protection has been activated	Wait three minutes after restarting the unit
	Timer is activated	Turn timer off
The unit starts and stops frequently	There's too much or too little refrigerant in the system	Check for leaks and recharge the system with refrigerant.
	Incompressible gas or moisture has entered the system.	Evacuate and recharge the system with refrigerant
	The compressor is broken	Replace the compressor
	The voltage is too high or too low	Install a manostat to regulate the voltage
Poor heating performance	The outdoor temperature is extremely low	Use auxiliary heating device
	Cold air is entering through doors and windows	Ensure that all doors and windows are closed during use
	Low refrigerant due to leak or long-term use	Check for leaks, re-seal if necessary and top off refrigerant
Indicator lamps continue flashing	The unit may stop operation or continue to run safely. If the indicator lamps continue to flash or error codes appear, wait for about 10 minutes. The problem may resolve itself. If not, disconnect the power, then connect it again. Turn the unit on. If the problem persists, disconnect the power and contact your nearest customer service center.	
Error code appears and begins with the letters as the following in the window display of indoor unit: E(x), P(x), F(x) EH(xx), EL(xx), EC(xx) PH(xx), PL(xx), PC(xx)		

* Diagnostic lights are a combination of lights that will illuminate in the display area on the unit. They are a combination of the lights you see during normal operation.

NOTE: If your problem persists after performing the checks and diagnostics listed in the Troubleshooting tables, turn off the unit immediately and contact an authorized service center.